Congratulations with your purchase and the choice for



Instruction manual Koala Creek® Rooftop Tent EIGER 160K.



-
-
- In case of question please ask your preferred Koala Creek® dealer.
 - KOALA CREEK® is a registered trade brand owned by TWISTIM, Outdoor in motion.

TWISTIM, Outdoor in motion.
Gadestraat 3
6165CH Geleen
The Netherlands
www.koalacreek.info



**KOALA
CREEK**

Why a Koala Creek® Rooftop Tent?

A Rooftop Tent is mounted provides high and dry sleeping on a car, truck, SUV and trailer. Designed for the true outdoorsman or for the best holiday . the Rooftop Tent is practical and simple eliminating the hassle of finding a flat dry location or spending extensive time setting up your tent.

Mother nature is no match for our sturdy Rooftop Tents.

You can use it in all 4 seasons.

Sleep safe above mud, rocks, dirt, critters and never wake up in a pool of water again!

Wake up feeling fresh and alive after a good nights sleep on a high-density foam mattress.

Lightweight and mounts on virtually any car, truck, SUV, 4x4 or trailer.

A Koala Creek® Rooftop tent has a lot of small details that make camping very comfortable.

Enjoy camping and outdoor with Koala Creek®

Koala Creek® offers a wide range of accessories you might need.

A DELUX package (can only be bought together with a new Rooftop Tent:

- 120 cm. long 12 volt LED light strip with roof mounting.
- Anti condensation mat to use under the mattress.
- 1 Luggage net for mounting in or under the tent.
- 2 shoebags to mount in the base plate slide in.

Several sizes car awnings.

A enamel Koala Creek® mug.

A Wheel step.

A pole set.

And off course spare materials in case you loose or damage something.

PACKING LIST:

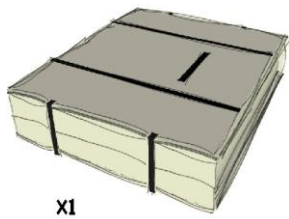

X1

1 × Roof Top Tent
(Tent & Foam mattress)



X1

1 × Ladder



X2

2 × Aluminum bar

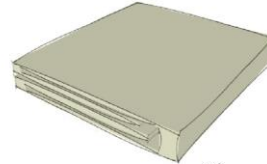

X1

1 × Travel Cover

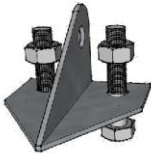

X2

2 × Sets for ladder

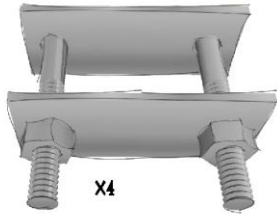

X4

4 × sliding sets for roof bar

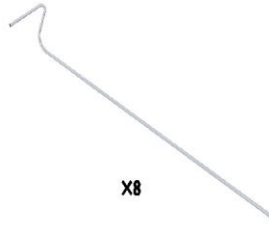

X6

6 × Spring rods

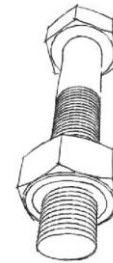

X8-16

8-16 × Bolt set



X2

2 × Wrench



X1

1 × Instruction

Included is also a set of Ladder supports.

2 Plastic brackets and mounting material to be mounted at the opposite side from the ladder brackets. To support the extracted ladder when opening the Rooftop Tent.

INSTALLATION MANUAL:

1. Open the carton carefully without cutting in the tent, take out all accessories from the tent inner.
2. Mount the alloy C bar under the bed base according to the 4 or 8 holes.
3. The Rooftop Tent has an alloy diamond tear plate outer baseplate. Please use extra washer between bar and base for easy sliding the mounting set.
4. When you have to mount alloy C bars in other direction please cut of ends of the bar.

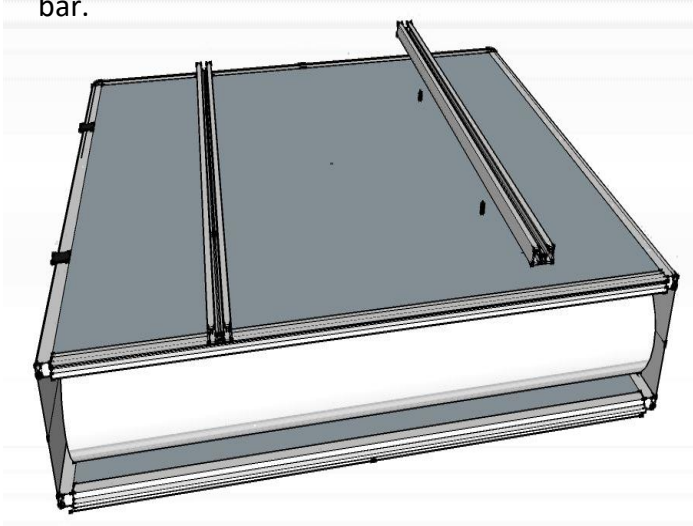

5. Fix the ladder to the tent base according to the reserve hole site under the bed base
6. Mount the extra set of ladder supports at other end of the base plate (opposite ladder mounting for support when ladder is extracted)

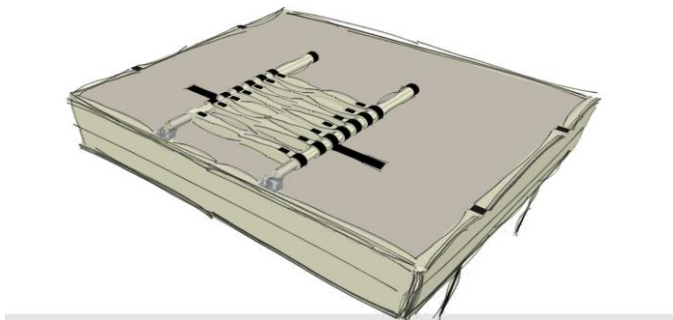

7. Choose a proper direction according to the roof bar of your car to install the tent on your car. Tighten all bolts and nuts carefully when correct positioned.

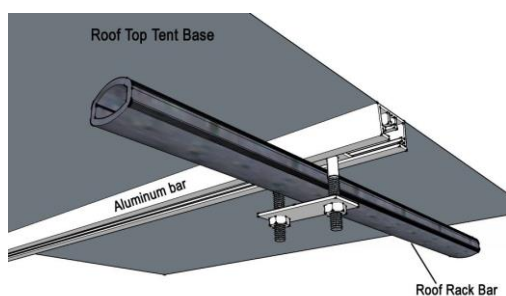

Side opening (Left or right is your choice)

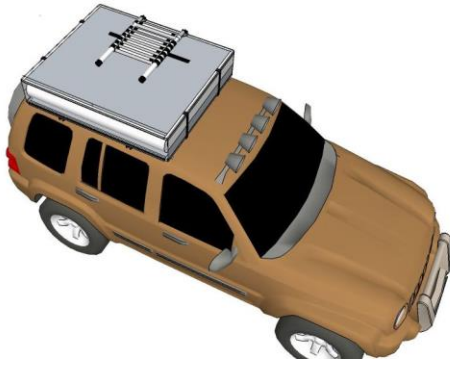

Rear open

(Most times you will have to mount alloy C bars in other direction under the Rooftent base plate)

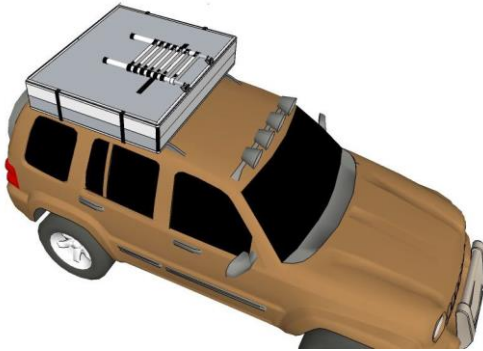

8. Please slide cover in the bed base, also the contra zipper with slide in.

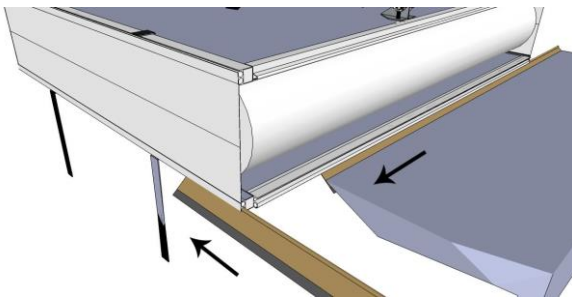

9. zip up the cover, fasten all straps.

REMARK: This is a special cover. On one side are 2 or 3 extra straps.

You can roll up the cover under the base when the Rooftop tent is in use.

There is also extra storage space on the sides beside the ladder, under the cover.

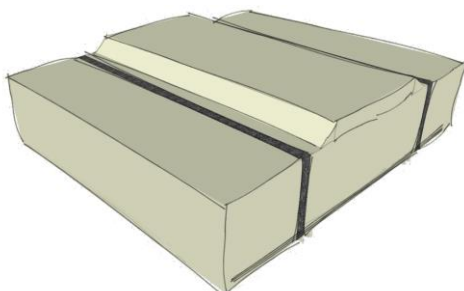

OPERATION INSTRUCTION:

1. Open the travel cover straps and by zipper, unfold and roll up the cover under the base plate. (with 2 or 3 extra straps in the cover)
2. unfasten the side straps and stretch out the ladder.



3. Set up the tent by dragging the ladder, adjust the position of the ladder.

IMPORTANT: The best angle for the ladder is a corner about 70-75 degrees.

IMPORTANT: The ladder should not push up the base, the 2 base plates need to “grip” into each other and have to be under an angle of 180 degrees to each other.



4. Dismount the 4 elastic bungee cords inside the Rooftop tent . These pull in the Rooftent fabric when uninstalling the Rooftop tent.
5. Set up the window & door flap by the spring rods or roll these up!



ANNEX (If you buy the additional annex room)

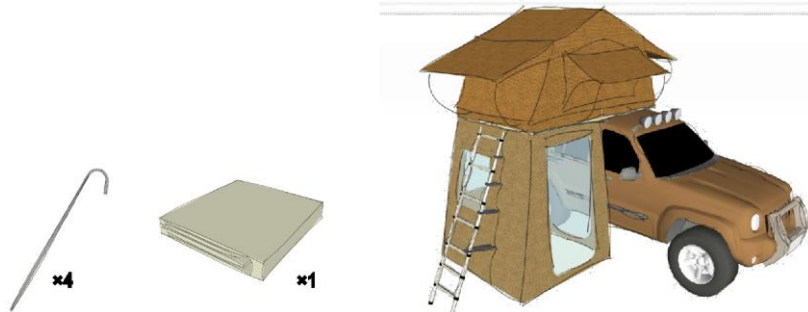

EIGER:

Slide the annex in the bed base, adjust it to its proper position, fasten straps to ladder and fix pegs.

CAUTIONS - WARNINGS

1. Please do not move the vehicle with open Rooftop Tent roof tent.
2. The maximum speed with the mounted Rooftop tent is 120km/h
3. Please use the ladder according to the ladder instruction.
4. The maximal load of the tent base is 300kg. Equally divided over the Rooftop tent base. Depending on the vehicle recommendations.
5. The fabric of tent is made of poly and cotton mix. This makes it completely waterproof and extremely resistant to mould and mildew. Hence it can be stowed in a wet condition for a short period of time. However, the roof tent should be completely dried and ventilated after every trip within 24 hour, otherwise, mould can form over a longer period of time. (Take care of a dry Rooftop tent when stored for a longer period)
6. When raining make sure that the inclination of the tent helps water to flow off.
7. ***Ensure regularly that all mounting materials of your rooftop tent are in good condition and properly tightened.
Check after first 100 Km. and during each trip.***

WARRANTY AND CONDITION

A Koala Creek® Rooftop tent is covered by 24 months warranty effective from date of purchase (for first owner and not on wear parts)

The problem occurs under normal used circumstances where the Rooftop tent has been used according instructions in this manual.

The problem is found to be caused by defective or faulty materials, workmanship or manufacturing process.

Original invoice has to taken over to the Koala Creek® preferred dealer.

Claims that are not covered by above regulations are not covered by warranty.

However, Koala Creek® will do always the utmost to help you, and all descisions have to be made by Koala Creek®.

Also when the period of 24 month has passed.

***In case of questions or problem please ask first your preferred Koala Creek® dealer where you bought your product.
He is specialised and always willing to help.***